



Pelarbacken health care center for homeless
Ersta Diakoni
Östgötagatan 10
116 25 Stockholm, Sweden

Department for homeless
Social service
Östgötagatan 101
16 25 Stockholm, Sweden



Treating Homeless People with High Levels of Comorbidity Using ACT, a Couple of first steps for 'Street Psychology'?

Olof Molander, lic. psychologist

molander.olof@gmail.com

AGENDA

- Homelessness in Sweden, definitions & common psychological problems
- Recommendations for treatments & triggers for substance abuse
- The contribution of ACT, conceptual model

DEFINITIONS

In Sweden, a homeless person is defined as an individual who

- has no permanent place to stay,
- who is referred to special lodging houses for the homeless or shelters for the night,
- who lives outdoors or who is currently in hospital or an institution, or
- who is imprisoned without a place of his/her own in which to stay when released

Pilotproject CBT/ACT for patients that are homeless

- 34 000 homeless in Sweden, 8 000 in Stockholm
- Welfare system and homelessness in Sweden.
Social service (housing & support)/health care.
- Collaborative pilotproject, psychosocial treatment for homeless patients with problems with addictions and mental ill-health.
- ~70 patients so far.
- Method tutoring by Jo Anne Dahl, Uppsala University.

Psychological problems of homeless people in Sweden

100%
Homeless
STATE OF CRISIS!

- Multiple stressors
- Rules/authorities
- Discrimination

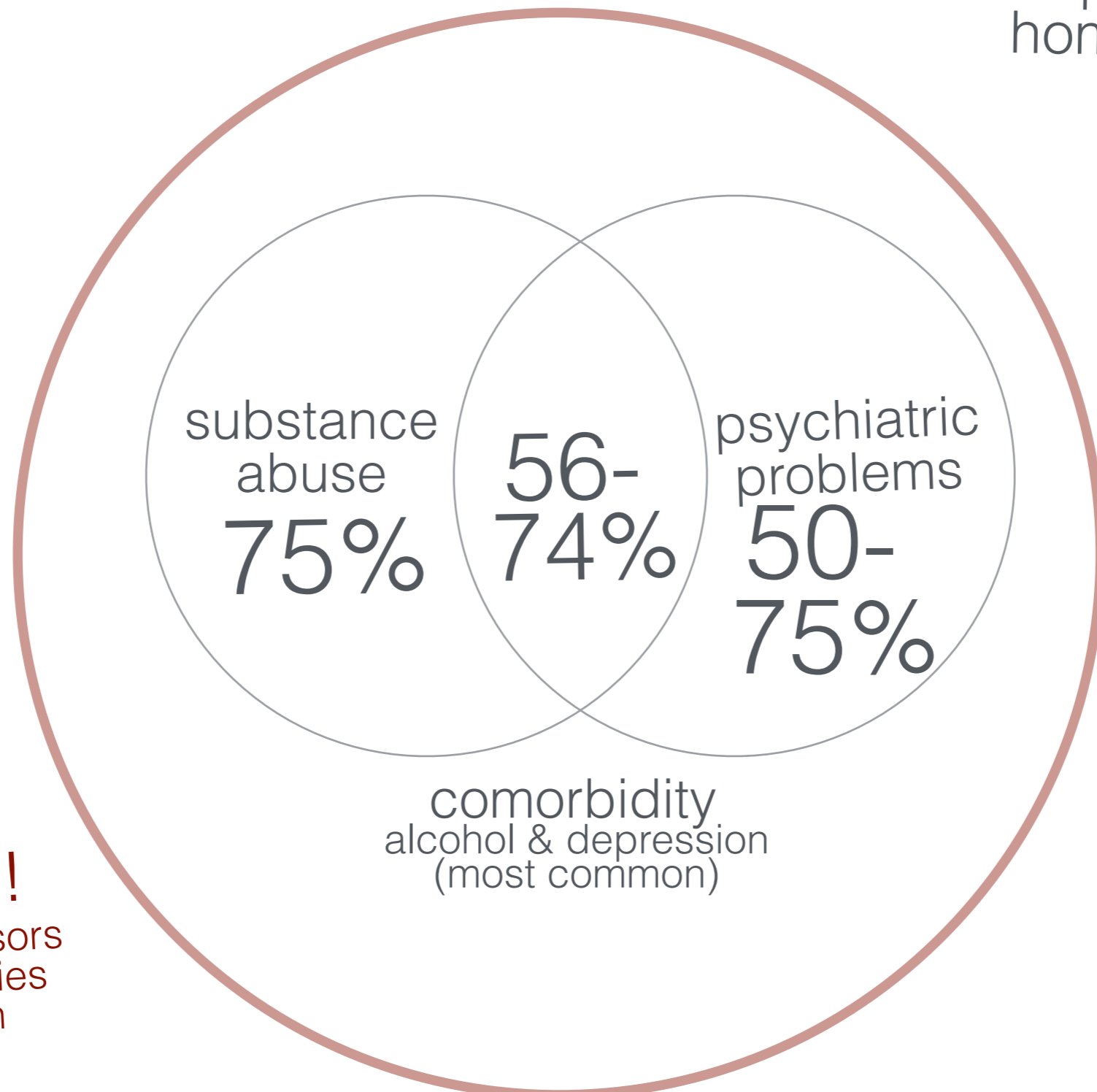

comorbidity
alcohol & depression
(most common)

"NUGGETS"

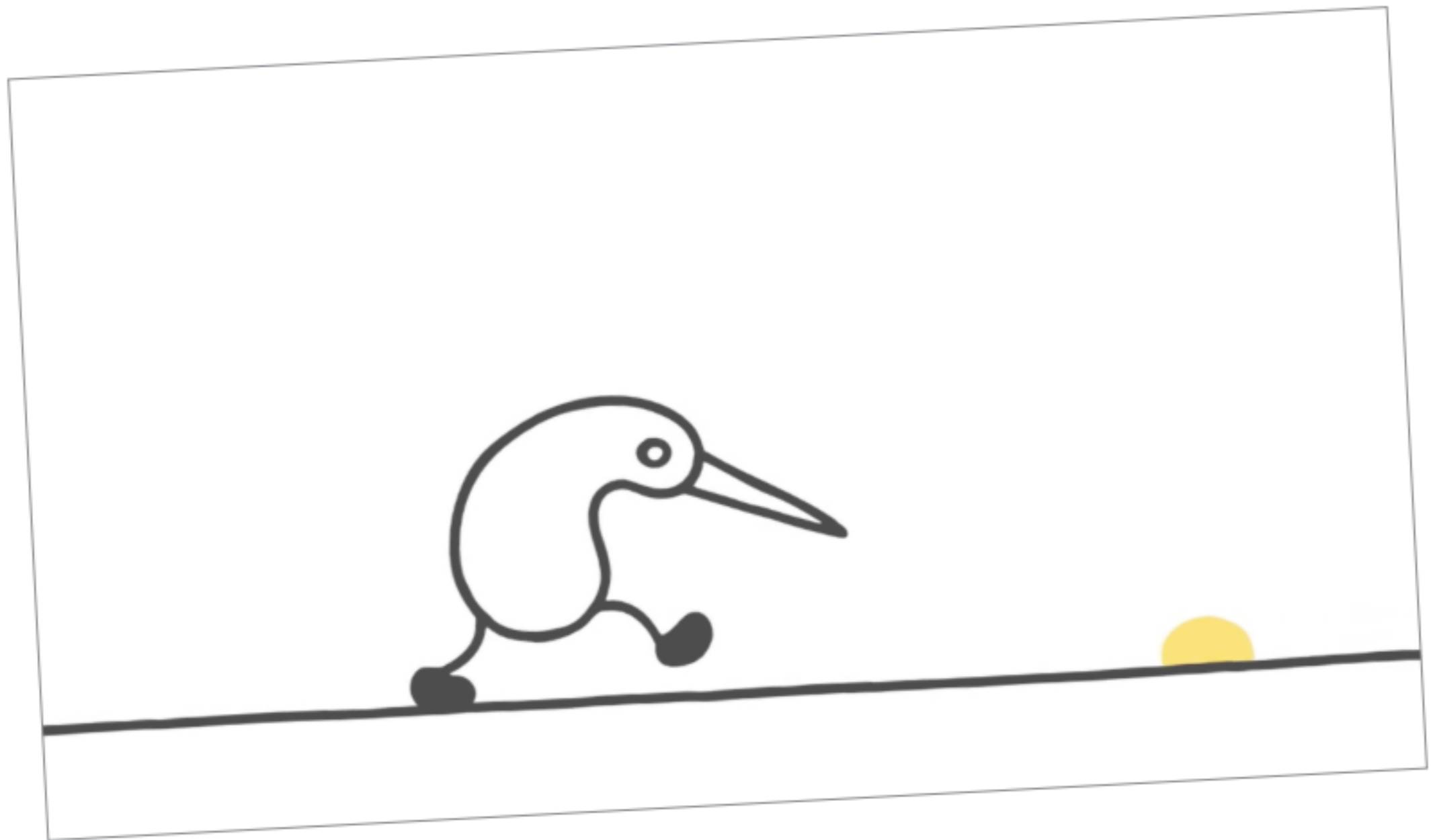

"SELF MEDICATION"



"SELF MEDICATION"



ACT
interventions
for values

casket
exercise

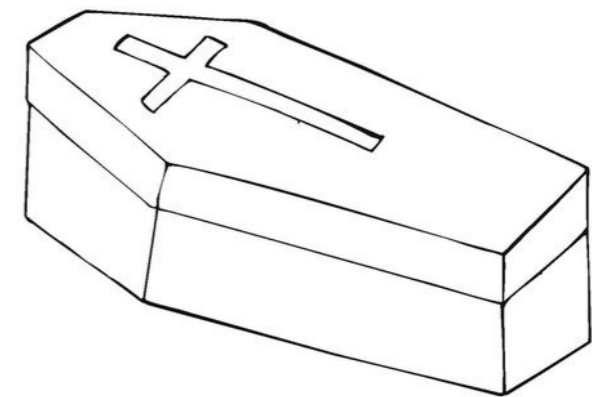

MORTALITY RATE

-after 5 year

Swedish homeless
in shelters or on the "street"

→ 4,7- 60 times higher
risk to die early,
compared to the
general population

MORTALITY RATE

-after 5 year

Swedish homeless
in shelters or on the "street"

→ 4,7- 60 times higher
risk to die early,
compared to the
general population

group
with
substance
abuse

→ 46% died

MORTALITY RATE

-after 5 year

Swedish homeless
in shelters or on the "street"

→ 4,7- 60 times higher
risk to die early,
compared to the
general population

group
with
substance
abuse

→ 46% died

Patients with cancer
in Sweden

→ 29% overall

→ 31-
51% brain tumors

→ 46-
51% leukemia

SOME RECOMMENDATIONS FOR PSYCHOSOCIAL TREATMENT FOR HOMELESS

- "Substance abuse and mental ill-health (comorbidity) is both a cause to and a consequence of homelessness"
- "Homeless patients reasons for using alcohol and drugs differ from other groups"
- "Integrated treatment for substance abuse and mental ill-health adjusted to the client group is recommended"

TRAJECTORY/WHAT HAPPENS?

- when cutting down or stop using alcohol/drugs

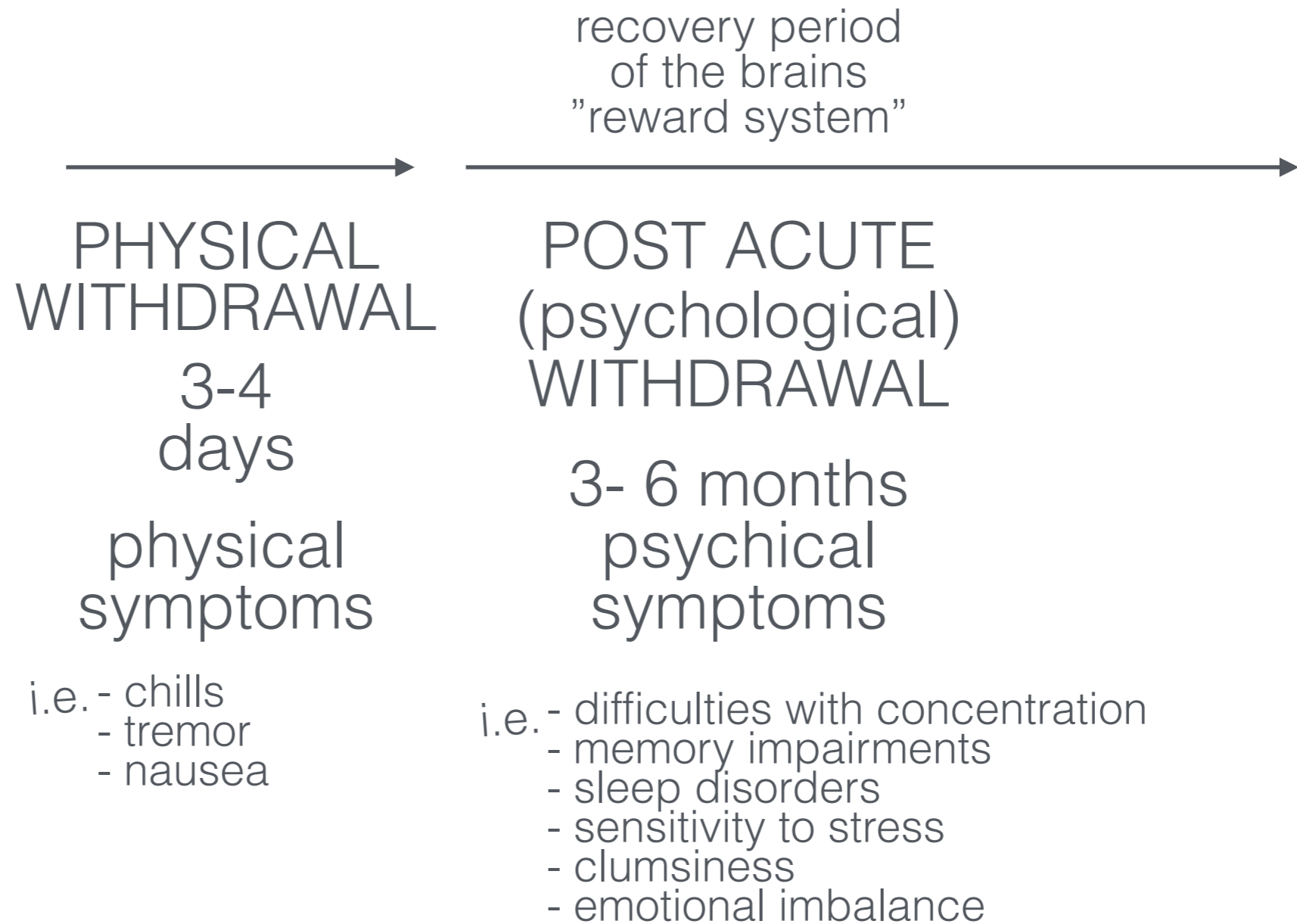
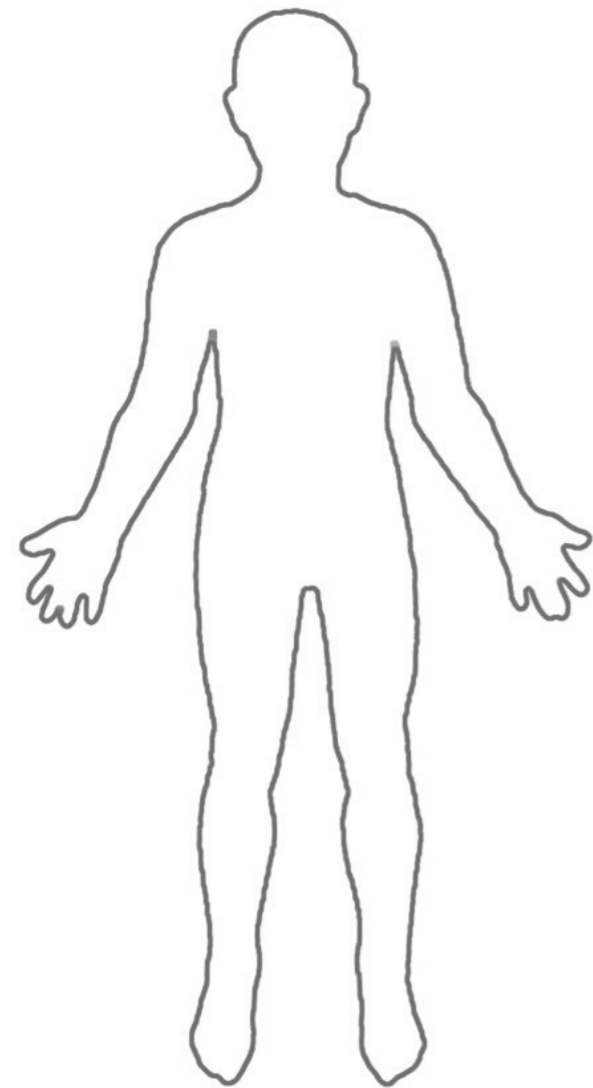

REASONS (TRIGGERS) FOR USE OF ALCOHOL/DRUGS (IDS-100)

Homeless patients (n=40) seeking treatment in pilot project

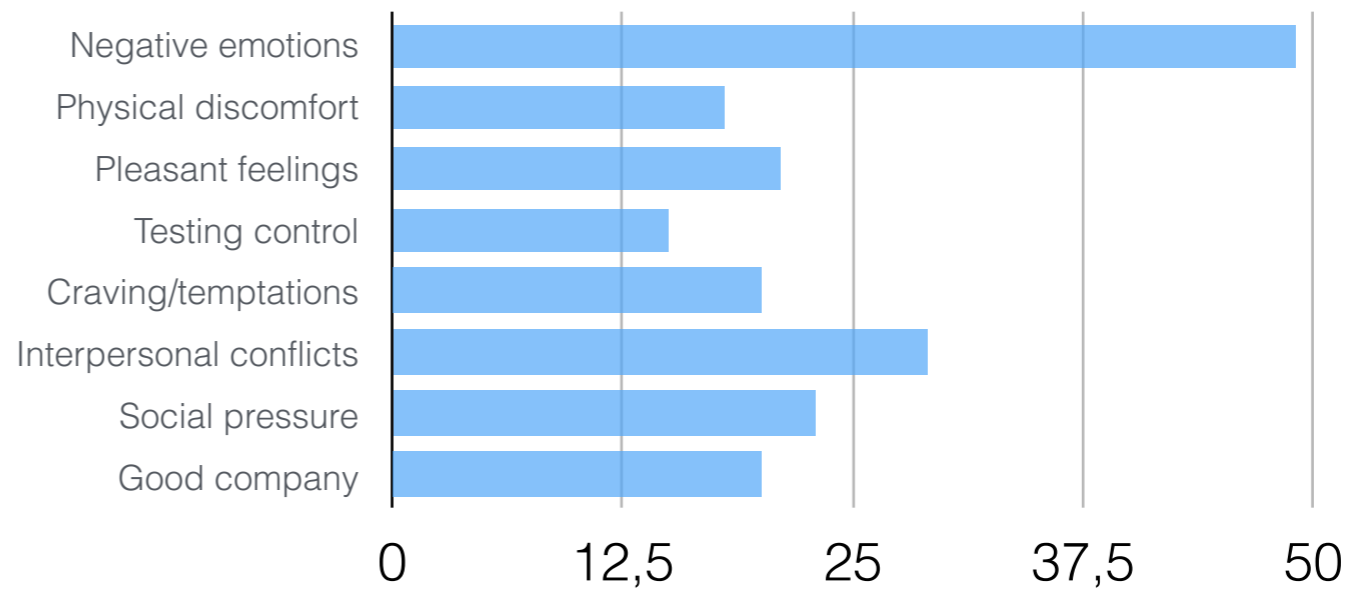

"ordinary" patients

job +
apartment
family
friends
hobbies
...

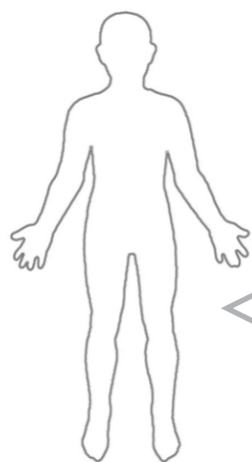

- PAW symptoms

"Live as usual for 6 months. Don't make any major changes. It will be better."

homeless patients

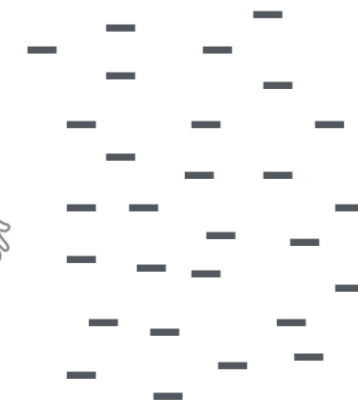
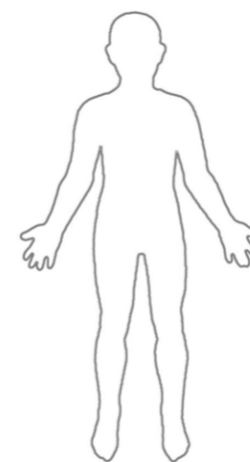
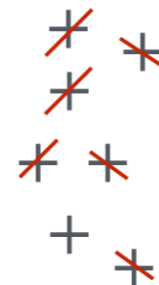

The contribution of Acceptance and Commitment Therapy

THE CONTRIBUTION OF ACT

- Standard CBT protocols seldom include components for dealing with negative emotions, even though this is the number one trigger for relapse.
- Functional contextual behavior analysis offers a good theoretical framework for understanding the psychological processes in "hard settings" as homelessness. I.e. shelters, living on the street or "moving" homeless clients.
- BA: Massive amounts of external triggers. Different avoidance behaviors that possibly share the same function for addictions and depression (EA, negative emotions). You have to work with more than just "using behaviors".
- Flexibility in the treatment process, as opposed to rules, "consequences" and punishments. I.e. lapses and relapses.
- Focus on function, (as opposed to symptomreduction), sometimes with ongoing drug use.
- And of course, values and a lot of committed action. Key for opening up for behavior change, and moving on in life.

"CONCEPTUAL MODEL"

- two states for substance abuse/depression

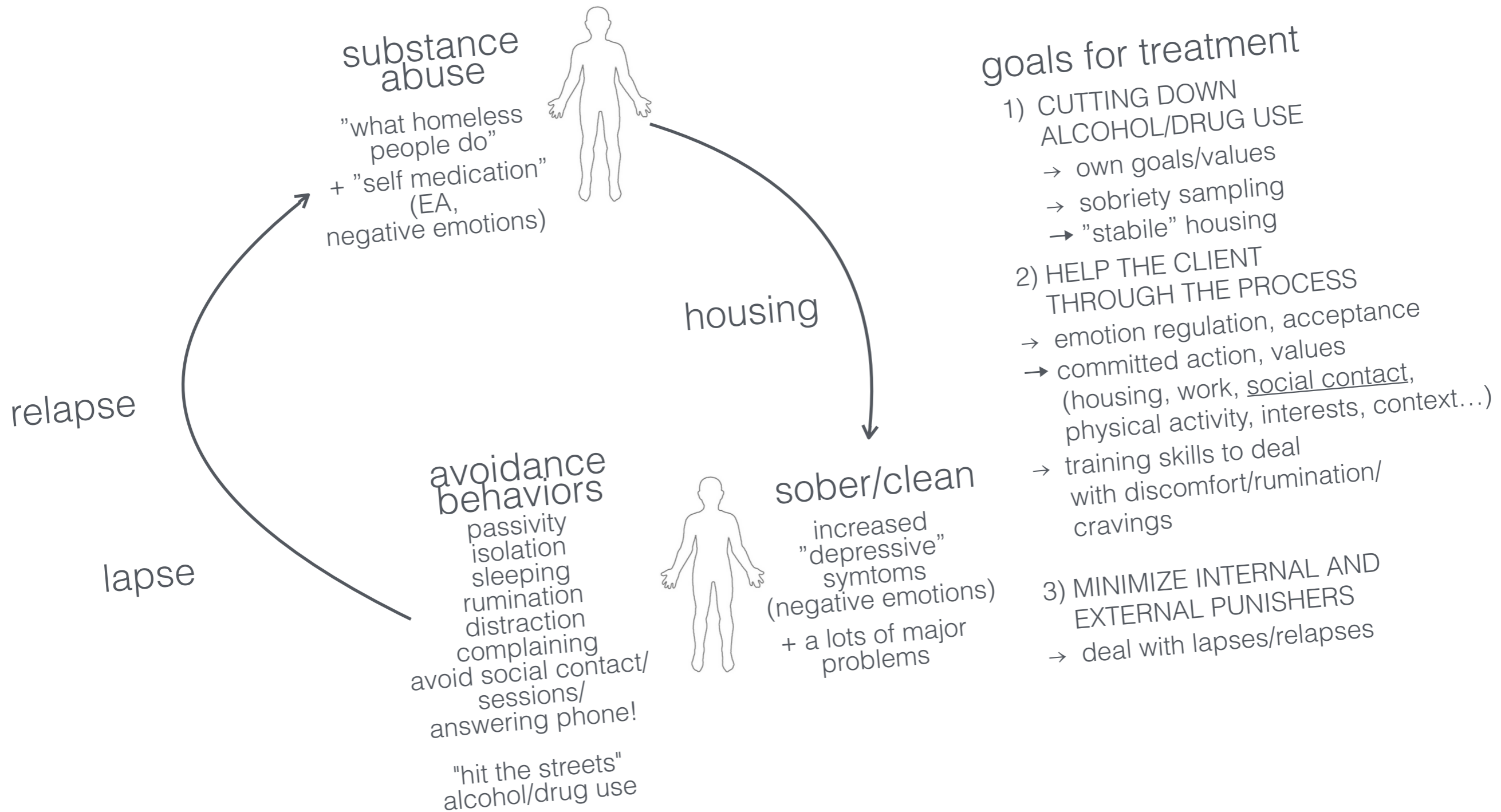

ACT, key processes/skills training

- inactivity/passivity → values/committed action
- experimental avoidance
(negative emotions) → acceptance
- fusion (rumination) → defusion
- psychological flexibility in treatment
(lapse/relapse)
(dealing with emergencies)

Questions?